

---

# 1W High Power LED

## Features

- Highest flux per LED family in the world
- Very long operating life (up to 100k hours)
- Available in Red, Yellow, Green, Blue, White
- Lambertian radiation pattern
- More energy efficient than incandescent and most halogen lamps
- Low voltage DC operated
- Cool beam, safe to the touch
- Fully dimmable
- No UV
- Superior ESD protection
- lower Rth
- RoHS compliant — Lead-free
- Instant light (less than 100ns )



1W Blue LED

## Applications

- Portable (flashlight, bicycle)
- Reading lights (car, bus, aircraft)
- Orientation
- Mini-accent
- Decorative
- Fiber optic alternative
- Appliance
- Sign and channel letter
- Architectural detail
- Cove lighting
- Automotive exterior (Stop-Tail-Turn,CHMSL,Mirror side repeat)
- Edge lit signs (Exit, point of sale)

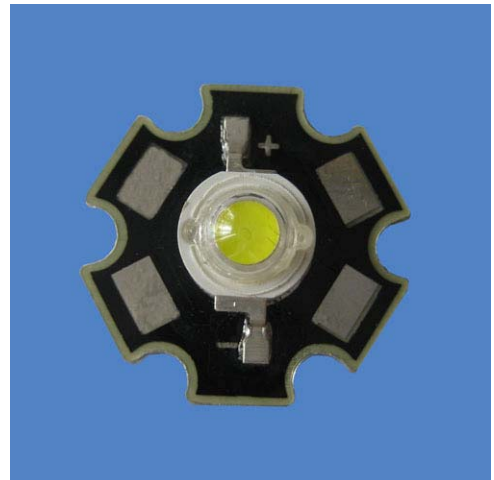

1W White LED & Aluminum PCB

## Catalog

1. Red 1W High Power LED .....	2
2. Yellow 1W High Power LED.....	4
3. Green 1W High Power LED .....	7
4. Blue 1W High Power LED .....	9
5. White 1W High Power LED .....	12
Package Dimensions (unit:mm) .....	14

## 1. Red 1W High Power LED

PART NO	Chip		Lens Color
	Material	Emitted Color	
LED-P1-D-Red	GaAlInP	Red ■	WATER CLEAR

### Absolute Maximum Ratings (Ta = 25°C)

Items	Symbol	Absolute Maximum Rating	Unit
Forward Current	IF	0.35	A
Peak Forward Current*	IFP	0.8	A
Reverse Voltage	VR	5	V
Power Dissipation	PD	1	W
Electrostatic discharge	ESD	±2000	V
Operation Temperature	TOPR	-40~+80	°C
Storage Temperature	TSTG	-40~+100	°C
Lead Soldering Temperature*	TSOL	Max. 260°C for 3sec Max.	

\*IFP Conditions: Pulse Width≤10msec duty≤1/10

\* Our MCPCB is usual use for installation and connection during application, but the ability of heat dissipation is not enough. If lighted, our high power stars will need better another type heat dissipation equipment. So we recommend the working time is not over 5 -10 seconds without any heat dissipation equipment.

\*Reflow, wave peak and soak stannum soldering etc. is not suitable for this products.

\*Suggest to solder it by professional high power LED soldering machine.

\*Can use in variable temperature searing iron with soldering condition :≤260 degree less than 3 seconds.

### Typical Electrical & Optical Characteristics ( Ta = 25°C)

Items	Symbol	Condition	Min.	Typ.	Max.	Unit
Forward Voltage	VF	IF=0.35A	2.0		2.6	V
Reverse Current	IR	VR=5V			50	uA
50% Power Angle	2θ1/2	IF=0.35A	110		140	deg
Luminous Intensity	φV	IF=0.35A	20		50	lm
Recommend Forward Current	IF			0.35		A
Wave Length	λd	IF=0.35A	620		630	nm

**Notes:**1.Tolerance of measurement of forward voltage ±0.1V.

2.Tolerance of measurement of peak Wavelength ±2.0nm.

3.Tolerance of measurement of luminous intensity ±15%.

**Typical Electrical/Optical Characteristics Curves (Ta=25° Unless Otherwise Noted)**

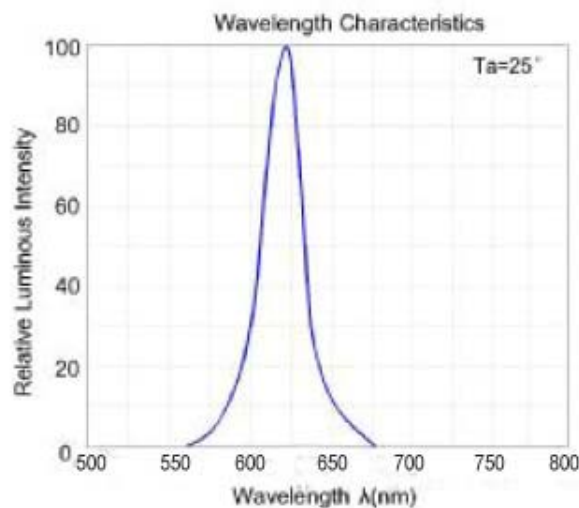
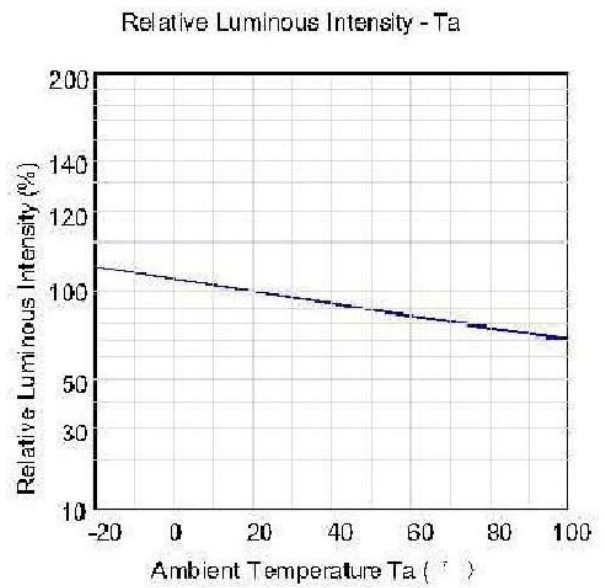
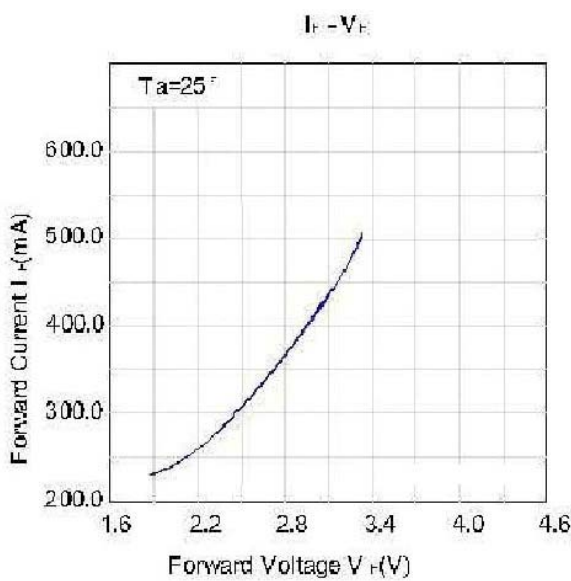
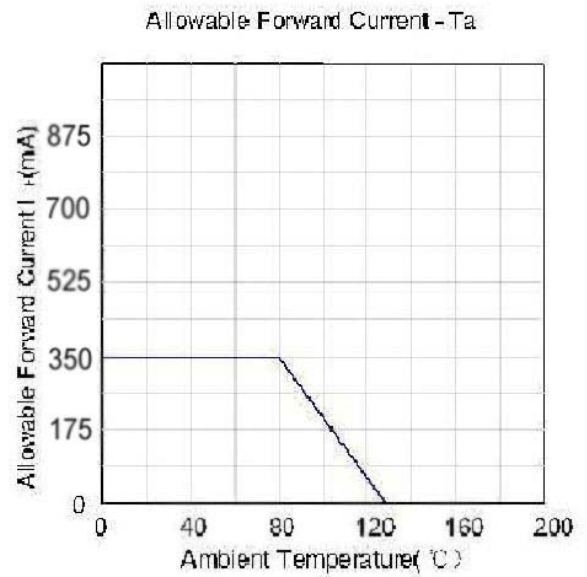
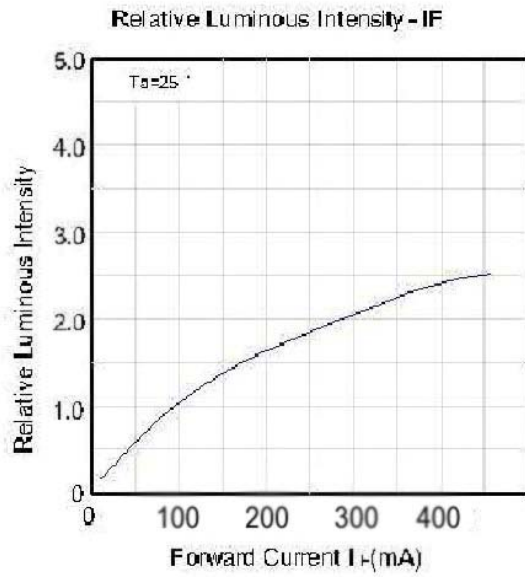

## Radiation Pattern

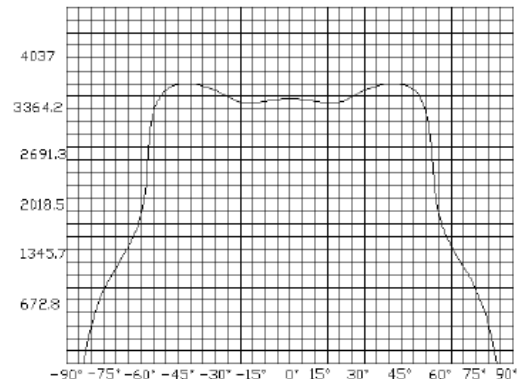
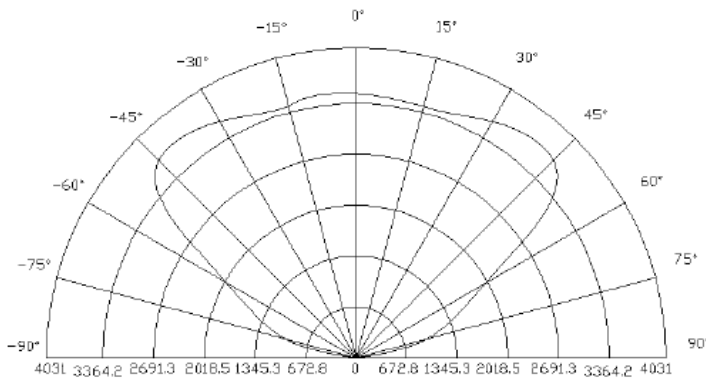

## 2. Yellow 1W High Power LED

PART NO	Chip		Lens Color
	Material	Emitted Color	
LED-P1-D-Yellow	GaAlInP	Yellow <span style="color: yellow;">■</span>	WATER CLEAR

### Absolute Maximum Ratings (Ta = 25 °C)

Items	Symbol	Absolute Maximum Rating	Unit
Forward Current	IF	0.35	A
Peak Forward Current*	IFP	0.8	A
Reverse Voltage	VR	5	V
Power Dissipation	PD	1	W
Electrostatic discharge	ESD	±2000	V
Operation Temperature	TOPR	-40~+80	°C
Storage Temperature	TSTG	-40~+100	°C
Lead Soldering Temperature*	TSOL	Max. 260°C for 3sec Max.	

\*IFP Conditions: Pulse Width≤10msec duty≤1/10

\* Our MCPCB is usual use for installation and connection during application, but the ability of heat dissipation is not enough. If lighted, our high power stars will need better another type heat dissipation equipment. So we recommend the working time is not over 5 -10 seconds without any heat dissipation equipment.

\*Reflow, wave peak and soak stannum soldering etc. is not suitable for this products.

\*Suggest to solder it by professional high power LED soldering machine.

\*Can use in variable temperature searing iron with soldering condition :≤260 degree less than 3 seconds.

## Typical Electrical & Optical Characteristics ( Ta = 25°C)

Items	Symbol	Condition	Min.	Typ.	Max.	Unit
Forward Voltage	VF	IF=0.35A	2.0		2.6	V
Reverse Current	IR	VR=5V			50	uA
50% Power Angle	2θ1/2	IF=0.35A	110		140	deg
Luminous Intensity	φV	IF=0.35A	20		50	lm
Recommend Forward Current	IF			0.35		A
Wave Length	λd	IF=0.35A	580		595	nm

- Notes:**
- 1.Tolerance of measurement of forward voltage  $\pm 0.1V$ .
  - 2.Tolerance of measurement of peak Wavelength  $\pm 2.0nm$ .
  - 3.Tolerance of measurement of luminous intensity  $\pm 15\%$ .

## Typical Electrical/Optical Characteristics Curves (Ta=25° Unless Otherwise Noted)

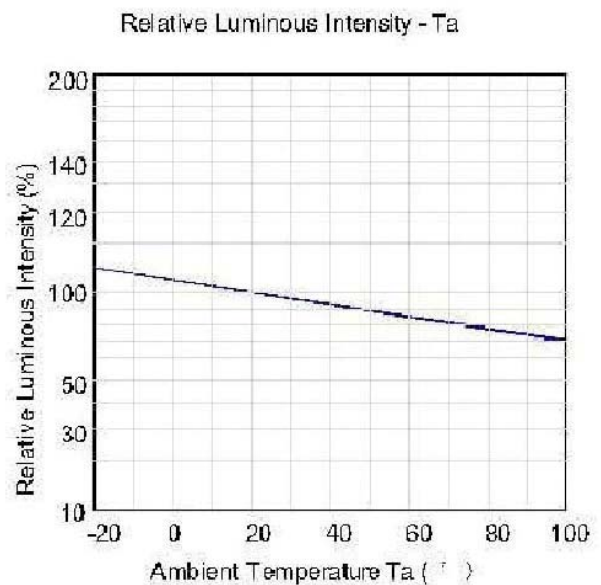
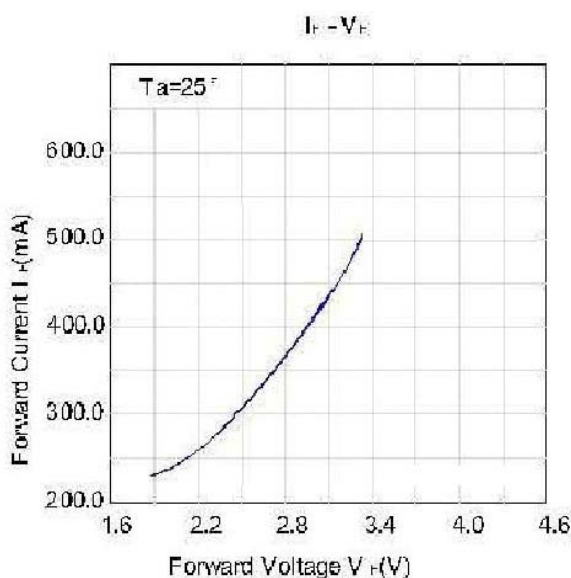
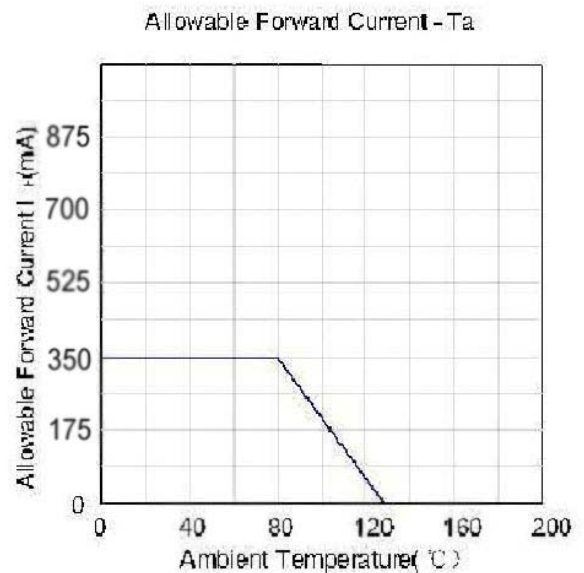
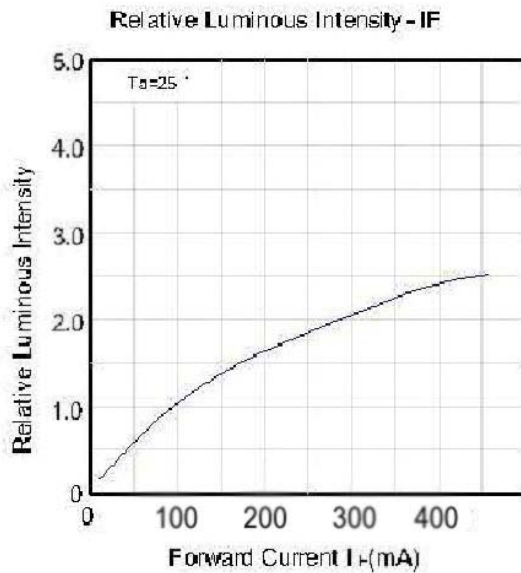

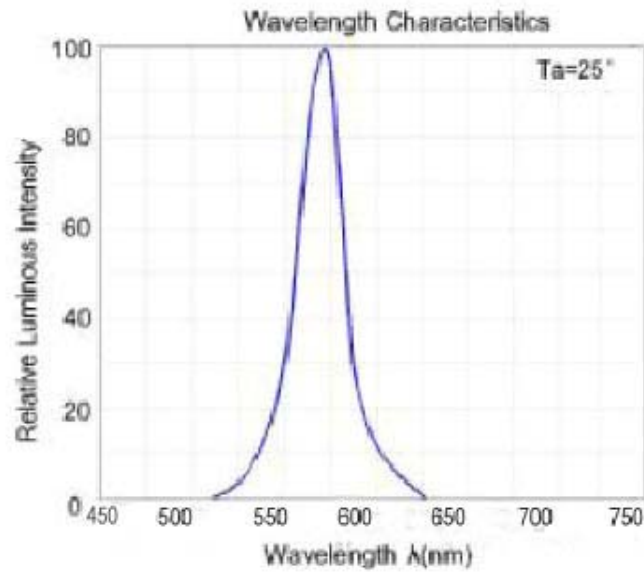

**Radiation Pattern**

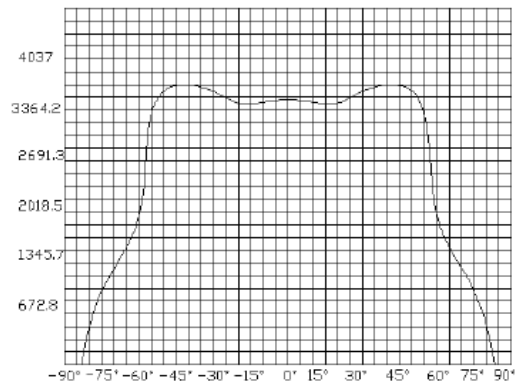
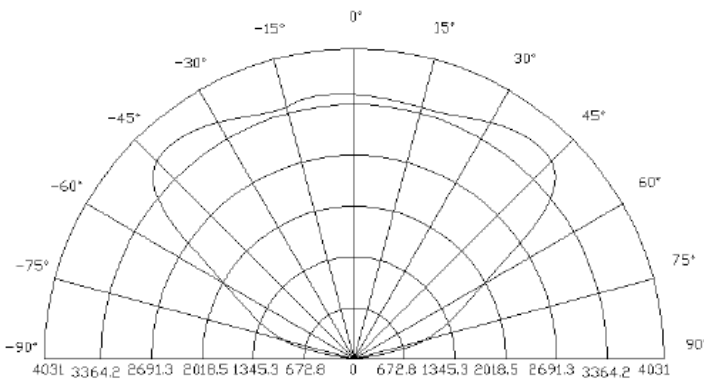

### 3. Green 1W High Power LED

PART NO	Chip		Lens Color
	Material	Emitted Color	
LED-P1-D-Green	InGaN	Green ■	WATER CLEAR

#### Absolute Maximum Ratings (Ta = 25°C)

Items	Symbol	Absolute Maximum Rating	Unit
Forward Current	IF	0.35	A
Peak Forward Current*	IFP	0.8	A
Reverse Voltage	VR	5	V
Power Dissipation	PD	1	W
Electrostatic discharge	ESD	±2000	V
Operation Temperature	TOPR	-40~+80	°C
Storage Temperature	TSTG	-40~+100	°C
Lead Soldering Temperature*	TSOL	Max. 260°C for 3sec Max.	

\*IFP Conditions: Pulse Width≤10msec duty≤1/10

\* Our MCPCB is usual use for installation and connection during application, but the ability of heat dissipation is not enough. If lighted, our high power stars will need better another type heat dissipation equipment. So we recommend the working time is not over 5 -10 seconds without any heat dissipation equipment.

\*Reflow, wave peak and soak stannum soldering etc. is not suitable for this products.

\*Suggest to solder it by professional high power LED soldering machine.

\*Can use in variable temperature searing iron with soldering condition :≤260 degree less than 3 seconds.

#### Typical Electrical & Optical Characteristics ( Ta = 25°C)

Items	Symbol	Condition	Min.	Typ.	Max.	Unit
Forward Voltage	VF	IF=0.35A	3.0		3.6	V
Reverse Current	IR	VR=5V			50	uA
50% Power Angle	2θ1/2	IF=0.35A	110		140	deg
Luminous Intensity	φV	IF=0.35A	60		80	lm
Recommend Forward Current	IF			0.35		A
Wave Length	λd	IF=0.35A	520		530	nm

**Notes:**1.Tolerance of measurement of forward voltage ±0.1V.

2.Tolerance of measurement of peak Wavelength ±2.0nm.

3.Tolerance of measurement of luminous intensity ±15%.

**Typical Electrical/Optical Characteristics Curves (Ta=25° Unless Otherwise Noted)**

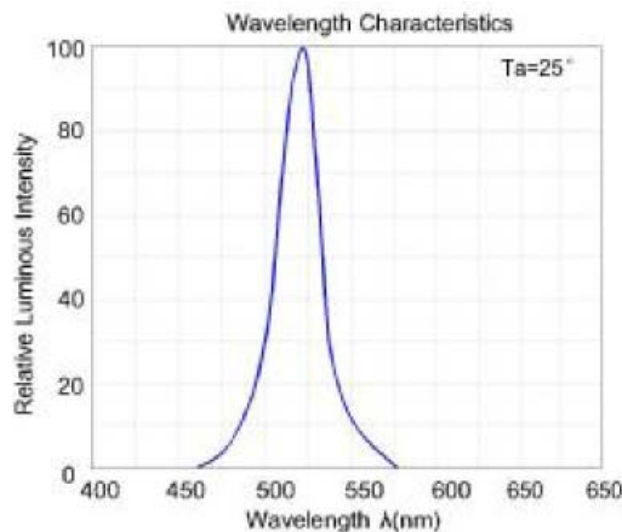
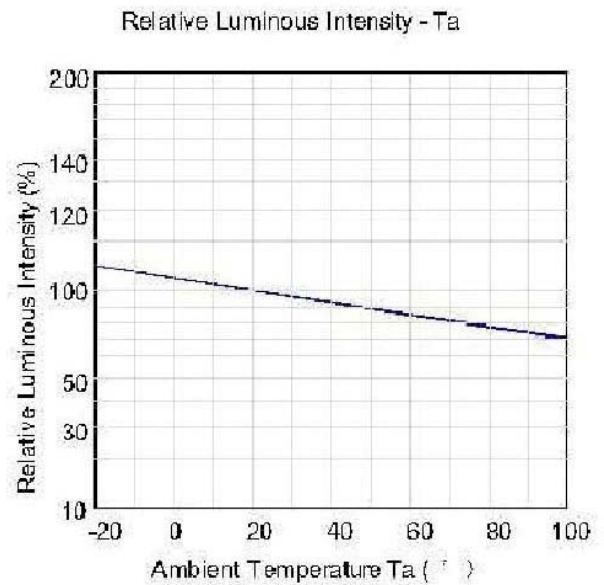
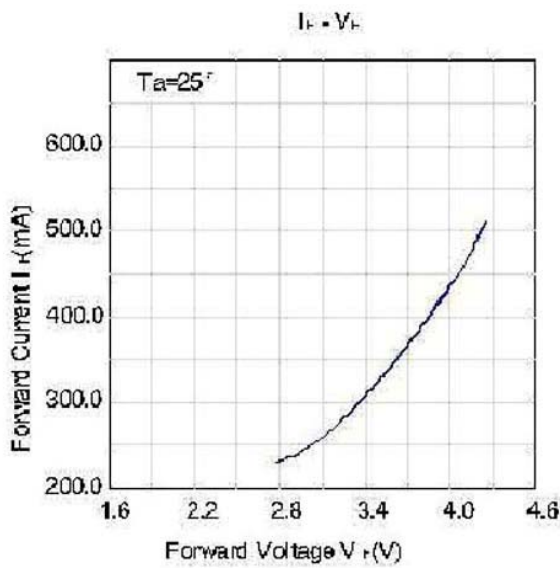
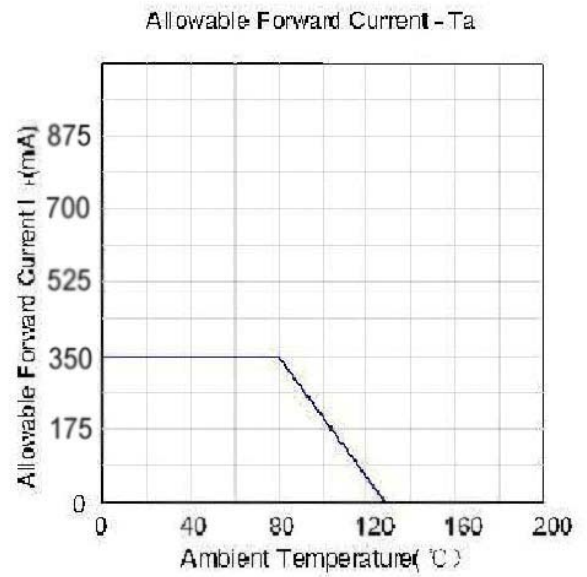
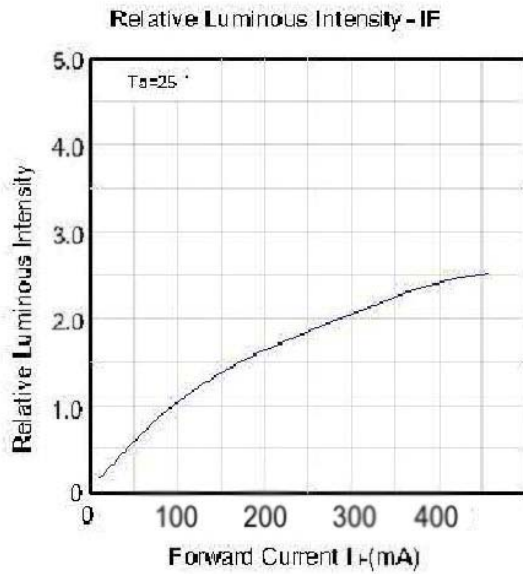



## Radiation Pattern

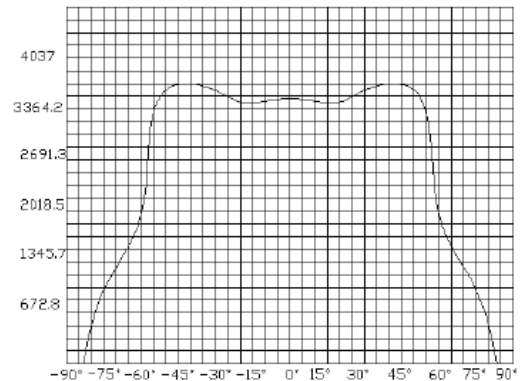
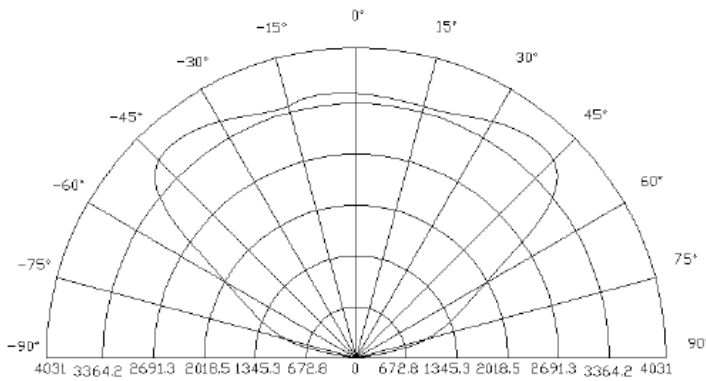

## 4. Blue 1W High Power LED

PART NO	Chip		Lens Color
	Material	Emitted Color	
LED-P1-D-Blue	InGan	Blue ■	WATER CLEAR

### Absolute Maximum Ratings (Ta = 25°C)

Items	Symbol	Absolute Maximum Rating	Unit
Forward Current	IF	0.35	A
Peak Forward Current*	IFP	0.8	A
Reverse Voltage	VR	5	V
Power Dissipation	PD	1	W
Electrostatic discharge	ESD	±2000	V
Operation Temperature	TOPR	-40~+80	°C
Storage Temperature	TSTG	-40~+100	°C
Lead Soldering Temperature*	TSOL	Max. 260°C for 3sec Max.	

\*IFP Conditions: Pulse Width≤10msec duty≤1/10

\* Our MCPCB is usual use for installation and connection during application, but the ability of heat dissipation is not enough. If lighted, our high power stars will need better another type heat dissipation equipment. So we recommend the working time is not over 5 -10 seconds without any heat dissipation equipment.

\*Reflow, wave peak and soakstannum soldering etc. is not suitable for this products.

\*Suggest to solder it by professional high power LED soldering machine.

\*Can use in variable temperature searing iron with soldering condition :≤260 degree less than 3 seconds.

## Typical Electrical & Optical Characteristics ( Ta = 25°C)

Items	Symbol	Condition	Min.	Typ.	Max.	Unit
Forward Voltage	VF	IF=0.35A	3.0		3.6	V
Reverse Current	IR	VR=5V			50	uA
50% Power Angle	2θ1/2	IF=0.35A	110		140	deg
Luminous Intensity	φV	IF=0.35A	10		30	lm
Recommend Forward Current	IF			0.35		A
Wave Length	λd	IF=0.35A	460		470	nm

Notes: 1. Tolerance of measurement of forward voltage  $\pm 0.1V$ .

2. Tolerance of measurement of peak Wavelength  $\pm 2.0nm$ .

3. Tolerance of measurement of luminous intensity  $\pm 15\%$ .

## Typical Electrical/Optical Characteristics Curves (Ta=25° Unless Otherwise Noted)

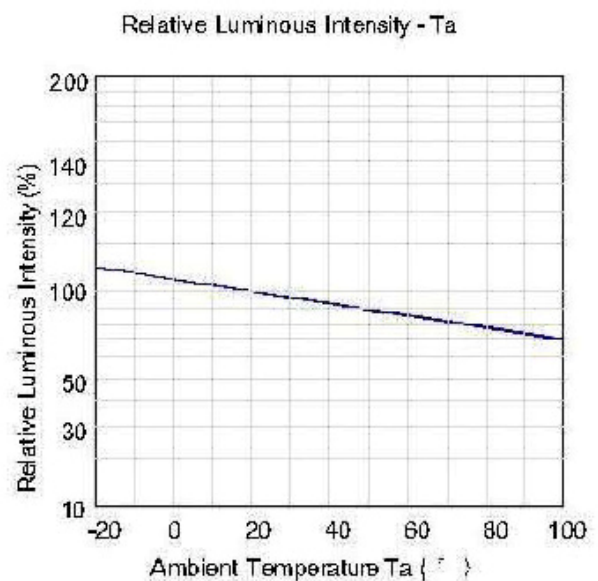
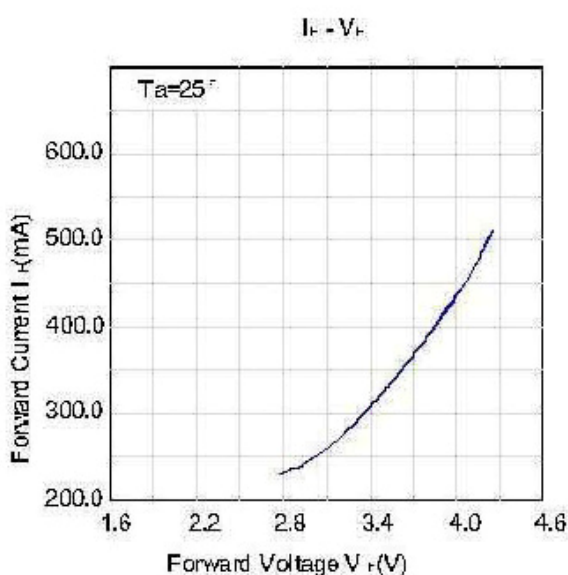
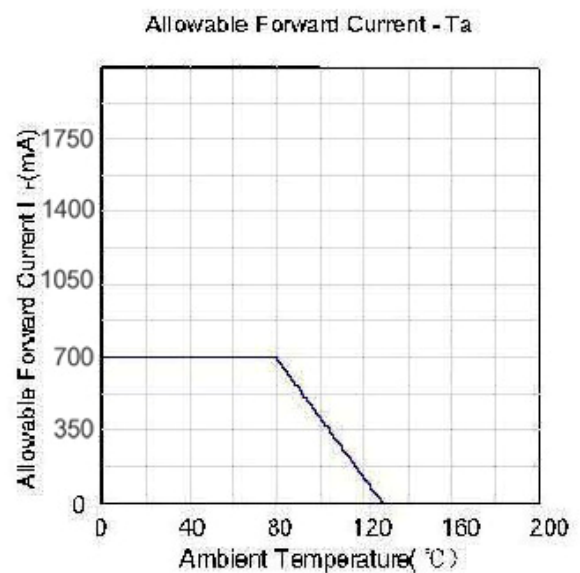
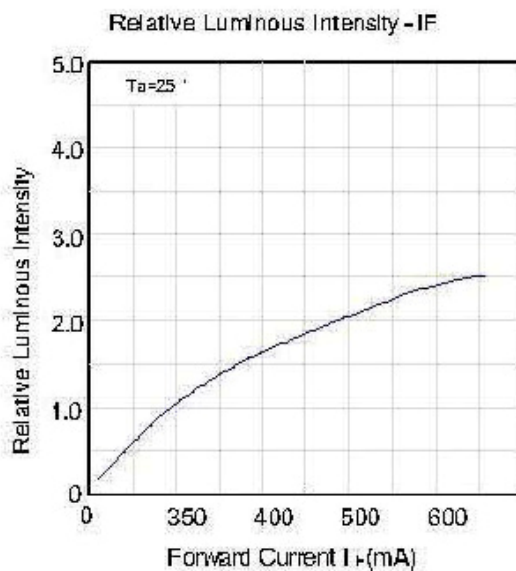

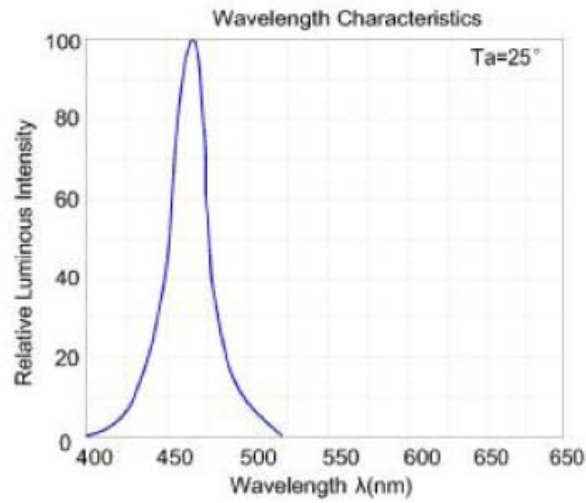

**Radiation Pattern**

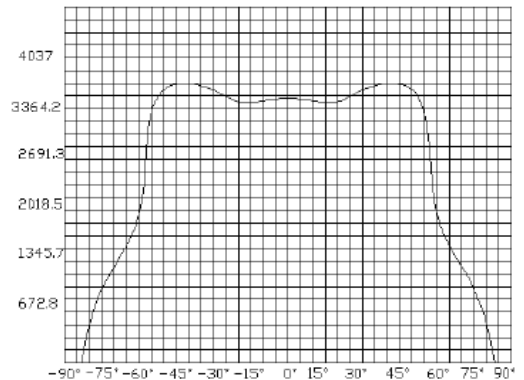
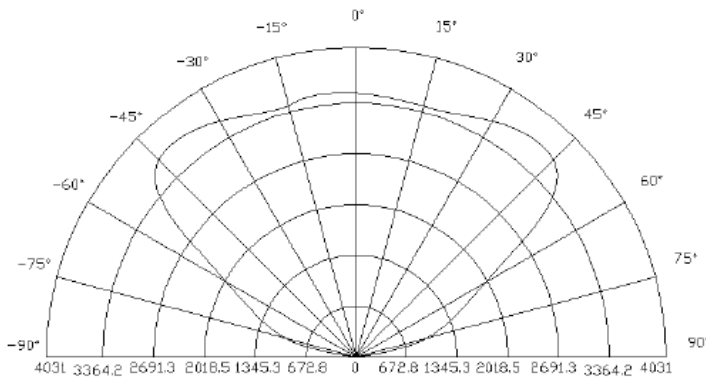

## 5. White 1W High Power LED

PART NO	Chip		Lens Color
	Material	Emitted Color	
LED-P1-D-White	InGaN	White □	WATER CLEAR

### Absolute Maximum Ratings (Ta = 25°C)

Items	Symbol	Absolute Maximum Rating	Unit
Forward Current	IF	0.35	A
Peak Forward Current*	IFP	0.8	A
Reverse Voltage	VR	5	V
Power Dissipation	PD	1	W
Electrostatic discharge	ESD	±4500	V
Operation Temperature	TOPR	-40~+80	°C
Storage Temperature	TSTG	-40~+100	°C
Lead Soldering Temperature*	TSOL	Max. 260°C for 3sec Max.	

\*IFP Conditions: Pulse Width≤10msec duty≤1/10

\* Our MCPCB is usual use for installation and connection during application, but the ability of heat dissipation is not enough. If lighted, our high power stars will need better another type heat dissipation equipment. So we recommend the working time is not over 5 -10 seconds without any heat dissipation equipment.

\*Reflow, wave peak and soakstannum soldering etc. is not suitable for this products.

\*Suggest to solder it by professional high power LED soldering machine.

\*Can use in variable temperature searing iron with soldering condition :≤260 degree less than 3 seconds.

### Typical Electrical & Optical Characteristics ( Ta = 25°C)

Items	Symbol	Condition	Min.	Typ.	Max.	Unit
Forward Voltage	VF	IF=0.35A	3.2		3.6	V
Reverse Current	IR	VR=5V			50	uA
50% Power Angle	2θ1/2	IF=0.35A	110		140	deg
Luminous Intensity	φV	IF=0.35A	80		90	lm
Recommend Forward Current	IF			0.35		A
Chromaticity	Tc	IF=0.35A	6000		6500	k
White Color Region	--					
Chromaticity Coordinates	X=--		Y=--			
Thermal Resistance, Junction to Case	RJP	IF=0.35A		10		°C/W

**Notes:**1.Tolerance of measurement of forward voltage ±0.1V.

2.Tolerance of measurement of peak Wavelength ±2.0nm.

3.Tolerance of measurement of luminous intensity ±15%.

**Typical Electrical/Optical Characteristics Curves (Ta=25° Unless Otherwise Noted)**

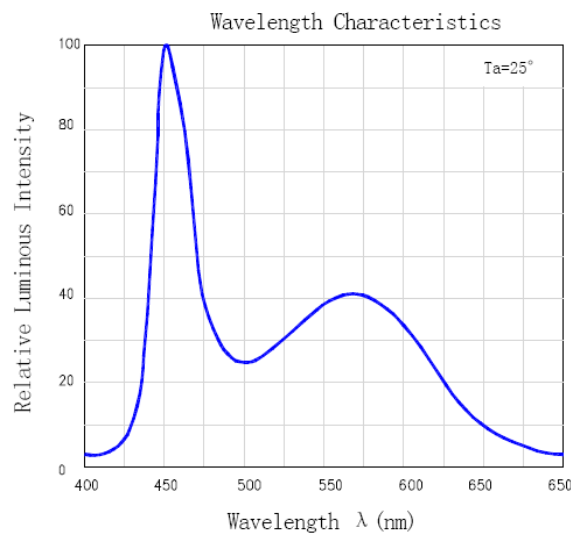
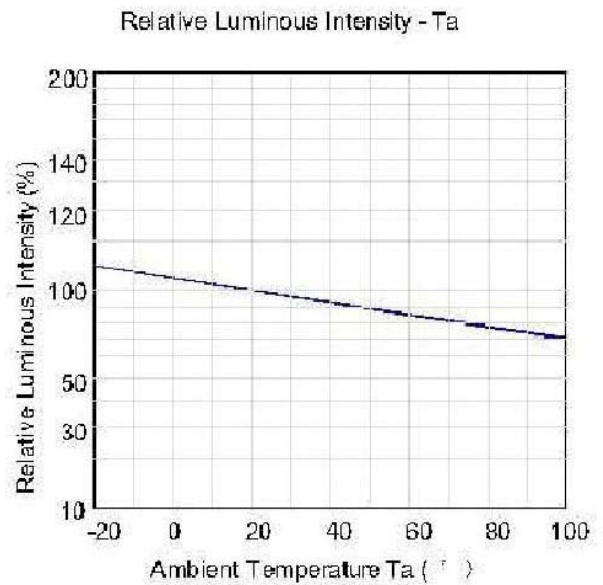
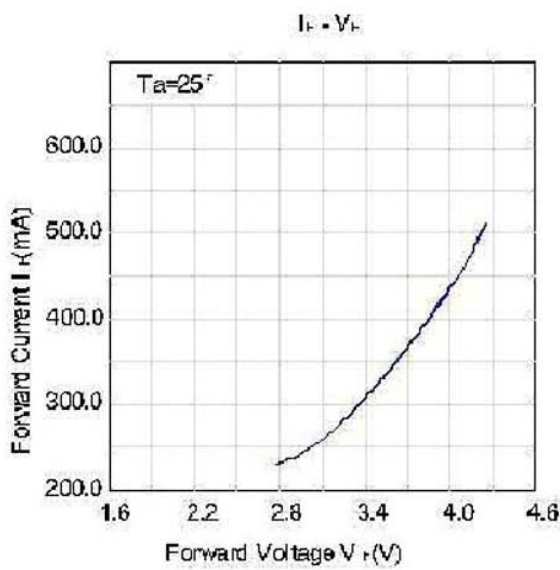
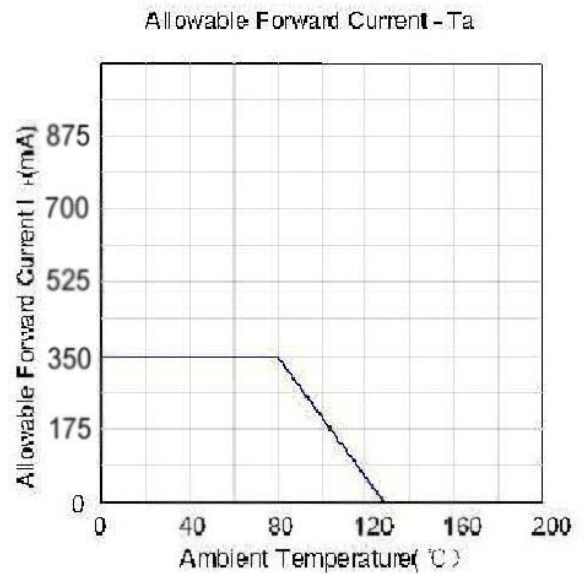
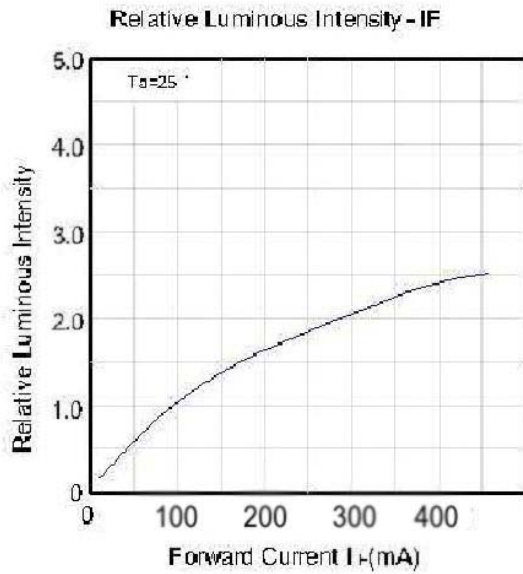

**Radiation Pattern**

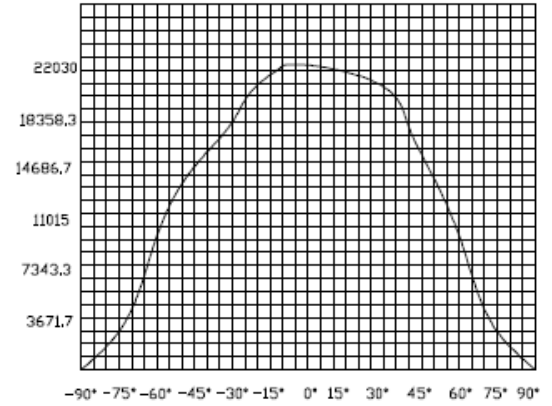
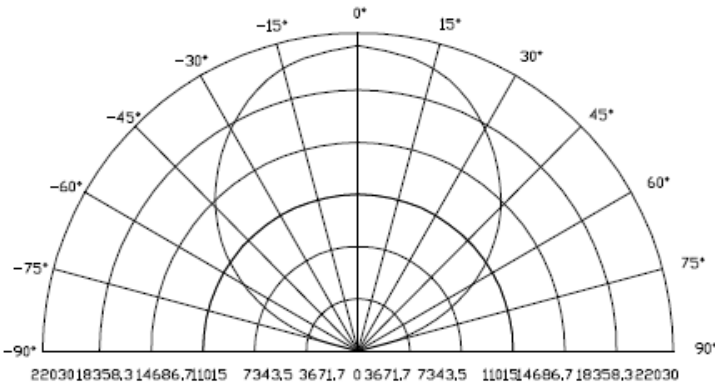

**Package Dimensions (unit:mm)**

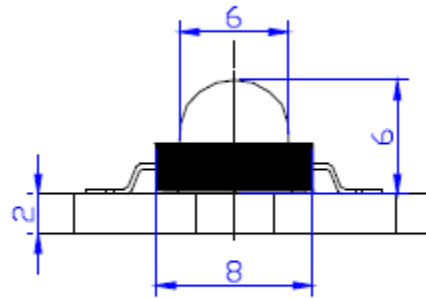
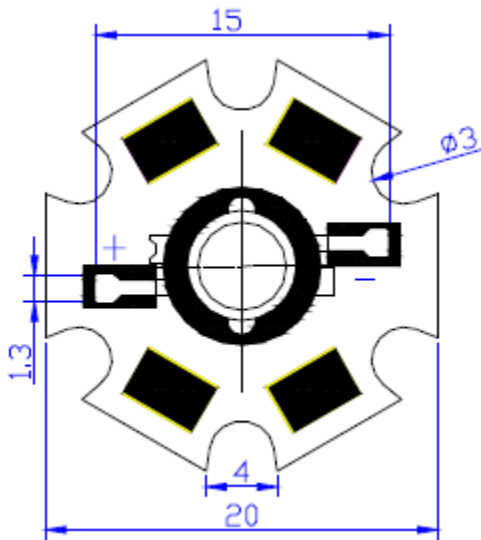

**Notes:**

All dimensions in mm tolerance is  $\pm 0.2\text{mm}$  unless otherwise noted.

## Box Dimensions

1W High Power LED	1W High Power LED & Aluminum PCB
50 pcs. Per Box	25 pcs. Per Box
Dimensions: 13.9mm * 15.0mm	Dimensions:13.9mm * 17.8mm
	

## Note the use of high-power LED

### Product Protection

LED is the electrostatic sensitive devices, so the product storage, transportation, application process, paying particular attention to static electricity, electromagnetic waves, and together with the necessary anti-static measures

### Safety Precautions

Harmful substances such devices include GaAs, GaAs dust and fumes are toxic, this product can not be broken, cutting or grinding, not with chemicals to dissolve.

### Design and Application

1. in the ratings to be used within the operating LED current limit function of the resistor. How much resistance will have to refer to the specific product specifications required to calculate the rated current plus that.
2. LED to be used in parallel mode, each LED channel by adding resistors are required, must not be led directly to multiple parallel.
3. circuits shall be designed to note: When the LED goes out to prohibit reverse voltage.
4. circuitry required to design note: the lights, turn off the lights when you prevent the instantaneous voltage.

5. solder direction (electrode direction) to be orthogonal with the direction of PCB.
6. high temperature will reduce its performance and reliability, please stay away from heat sources.

**Cleaning**

1. avoid the use of non-designated chemical solvents to clean the LED.  
For example: trichloroethene, chlorosilanes, acetone, difluoro esters.
2. If necessary cleaning carried out at room temperature, and not more than 1 minute.
3. When using any cleaning a chemical solvent to be especially careful, because some chemical solvents will damage the gel surface.
4. recommend the use of isopropyl alcohol or pure water (not tap water) for cleaning.
5. If using pure water, then immediately after cleaning dehumidifying, forced drying.

**Save**

1. before unpacking, LED should be stored in 30 °C / 90% RH or less environment. After opening the package, LED should be placed in 30 °C / 70% RH or below the environment
2. effective use for 1 year, after opening in 168H (7 days) of the exhausted.
3. If the use of desiccant fade or expired, the need to dry and roast: 60 ± 6°C / 24H.
4. LED James Gray lens easily, you need to do a good job related to dust control measures

**Pick and place**

Grasping LED can only touch on the body frame, tweezers, a tool can not put pressure on the lens, not to stamp, stab or push the lens.

**Heat treatment**

When the LED current drive is too large the T<sub>j</sub> (junction temperature) will exceed its limit, which can cause serious shorten the life of LED, the heat treatment measures to effectively reduce the thermal resistance applications. More common practice is to install the LED package device PCB board in the metal matrix. 1W LED products require heat the metal substrate surface area of at least 30 C m<sup>2</sup> (3W products recommended above 80 C m<sup>2</sup>), and its thermal conductivity is higher than 2.0W/mK. LED and thermal conductivity of metal substrate by a better combination of thermal plastic, thermal requirements Coefficient is higher than 1.0W/mK. thickness of less than 100um.

**Warranty**

All products manufactured by WAYJUN TECHNOLOGY are under warranty regarding defective materials for a period of two years from the date of delivery to the original purchaser.

**Copyright**

Copyright 2009, by ShenZhen Wayjun Technology Co.,Ltd. All rights are reserved. ShenZhen Wayjun Technology Co.,Ltd reserves the right to make improvements to the products described in this manual at any time without notice.

**Trademark**

The names used for identification only may be registered trademarks of their respective companies.

**Edition: V1.2**

**Date: March 2011**